



ARDUINO AND LORA BASED BUSSTOP REMINDER

Mr. Aruloli K.¹, Gomathi M.², Rathika V.³, Swetha J.⁴

Asst.Professor¹, UG Scholar², UG Scholar³, UG Scholar⁴

Department of Electrical and Electronics Engineering

Agni College of Technology, Chennai, Tamil Nadu, India

Abstract— Many bus stops also change their names at times or sometimes new bus stops to are added into existing routes. So here we propose a bus stop indicator system using Arduino Uno and Lora technology. We use Arduino Uno-based circuit along with Lora receiver-based circuit to be placed in buses. Also, we use an LCD to display the names of bus stops as they arrive. We use Lora transmitter-based circuits which will be placed on bus stops. This system does not need any bus stop names or route names to be stored in the bus system.

Keywords—Arduino UNO, Lora Module, Lora Antenna, Inter-Integrated Communication.

1. INTRODUCTION

In our habitual life peoples are moving from one place to another place by using transports. Government of Tamil Nadu and India providing public transport for peoples in their comfort zone. Here we considered one of the public transports is a bus, buses travel through several routes and crossing number of a bus stop in a day. some inevitable situations and many through several routes and crossing number of a bus stop in a day. Some inevitable situation and many times buses change their routes, peoples find difficulties to find bus stop names. So, we configured a bus stop reminder to remind bus stops by using Arduino and Lora technology. The Arduino and LORA-based bus stop reminder project can be made will be more powerful, efficient, and robust. A system that is integrated with an IOT platform. The IOT communication will enable the remote monitoring of bus stops and planning of alternate routes in case of emergencies.

2. EXISTING SYSTEM

is signal range detecting and in some cases bus changes their route from their original path of way leads to being very difficult. This will increase the cost of providing infrastructure which may not be utilized 100% of the time.

3. BLOCK DIAGRAM

Figure 1 shows the block diagram of the system.

4. PROPOSED SYSTEM

We use Arduino and Lora-based circuits along with RF receiver-based circuits to be placed in buses. Also, we use an

LCD to display the names of bus stops as they arrive. We use RF transmitter-based circuits which will be placed on bus stops. This system does not need any bus stop names or route names to be stored in the bus system. Each bus stop system has a code and our receiver circuitry can be fed with as well as edited of existing bus stop names using a USB keyboard interface. Each bus stop system constantly transmits a unique bus stop code. When the bus comes in a range of a bus stop the code is picked up by the bus system and it

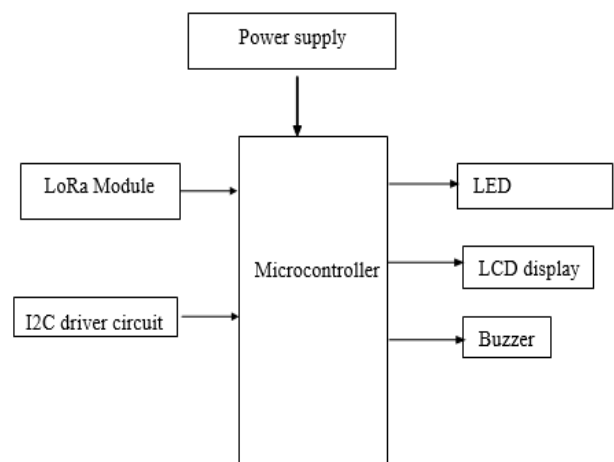

FIGURE 1: BLOCK DIAGRAM

The existing system will consist of a Raspberry single-board computer, RF transmitter, Rf receiver, LCD screen, and a sound speaker. It announces the bus stop names by using an RF transmitter and RF receiver. the main drawback of this system automatically feeds it to the controller. The controller processes this information to find out the name of a corresponding bus stop and immediately converts it to a voice command.

5. METHODOLOGY

A. LORA MODULE

LORA(short for long range) is a spread spectrum modulation technique derived from chirp spread spectrum (CSS) technology. It is a long-range low-power wireless platform that has become the de-facto technology for IOT networks worldwide. cell range urban 2-5km, rural 15-20km. Frequency band-ISM Bands: 433 MHZ/868 MHZ/780 MHZ/915 MHZ.

B. LCD

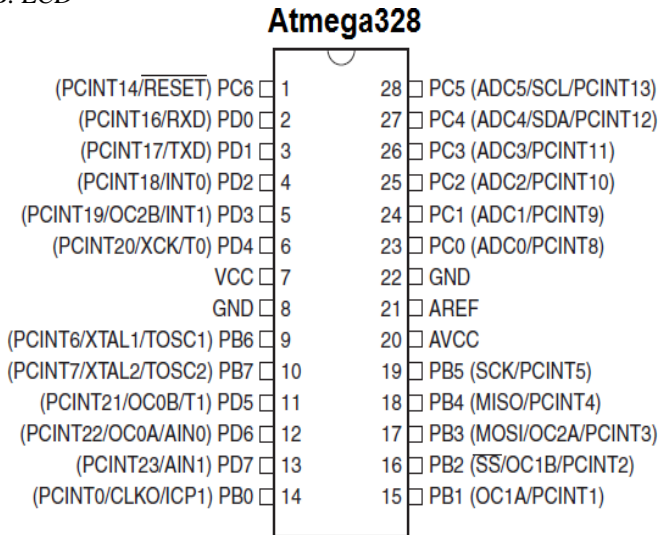

FIGURE 2: PIN DIAGRAM



FIGURE 3: LORA

C. ARDUINO UNO

Arduino Uno is a microcontroller board based on the ATmega328P. It has 14 digital input/output pins of which 6 can be used as PWM outputs, 6 analog inputs, a 16MHZ Quartz crystal, a USB connection, a power jack, an ICSP header, and a reset button. It contains everything needed to support the microcontroller, simply connect it to a computer with a USB cable or power it with an AC-to-DC adapter or battery to get started.



FIGURE 4: ARDUINO UNO

The operating voltage of this LCD is 4.7V-5.3V. It includes two rows where each row can procedure 16-characters. The utilization of current is 1mA with no backlight. Every character can be built with a 5* 8-pixel box. The alphanumeric LCDs alphabets and numbers. Its display can work on two models like 4-bit & 8-bit. These are obtainable in blue and green backlight.

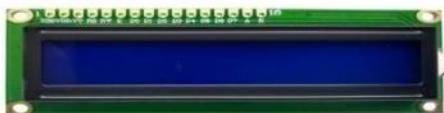

FIGURE 5: LCD

D. INTER-INTEGRATED COMMUNICATION

The character LCD is ideal for displaying text, numbers, and special characters. LCD incorporates a small add-on circuit(backpack) mounted on the back of the LCD module. The module features a controller chip handling I2C communications and an adjustable potentiometer for changing the intensity of the LED backlight. An I2C advantage is that wiring is straightforward, requiring only two data pins to control the LCD



FIGURE 6: INTER-INTEGRATED COMMUNICATION

E. LORA ANTENNA

Low-cost single-chip 2.4GHz GFSK RF transceiver IC. Range with Antenna: 250kb rate in an open area greater than 1000 meters. power range is ultra-low power consumption and its input voltage is 3.3V. It has 5V tolerant pins.



FIGURE 7: LORA ANTENNA

6. WORKING

we use Arduino and Lora-based circuits along with RF receiver-based circuits to be placed in buses. Also, we use an LCD to display the names of bus stops as they arrive. We use RF transmitter-based circuits which will be placed on bus stops. This system does not need any bus stop names or route names to be stored in the bus system. Each bus stop system has a code and our receiver circuitry can be fed with as well as edited of existing bus stop names using a USB keyboard interface. Each bus stop system constantly transmits a unique bus stop code. When the bus comes in a range of a bus stop the code is picked up by the bus system and it automatically feeds it to the controller. We are expecting to remind the bus stop of the bus and let the users know the location. So that one can manage their time efficiently and get the reminder just before the bus arrives or take an alternate means of transport if they miss the bus stop or they are running late. The controller process this information to find out the name of a corresponding bus stop and immediately converts it to a voice command.

7. HARDWARE IMPLEMENTATION

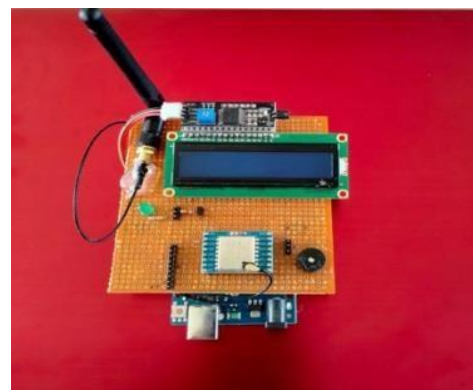

FIGURE 8: TRANSMITTER

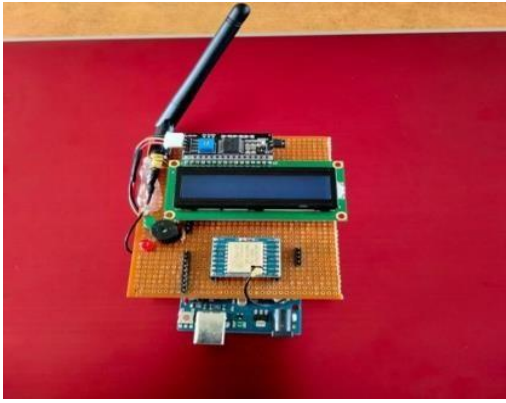

FIGURE 9: RECEIVER

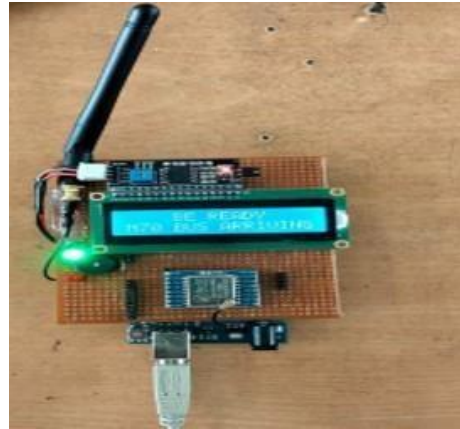

FIGURE 13: RECEIVER RESULT 2

8. RESULTS

A. RESULT OF TRANSMITTER

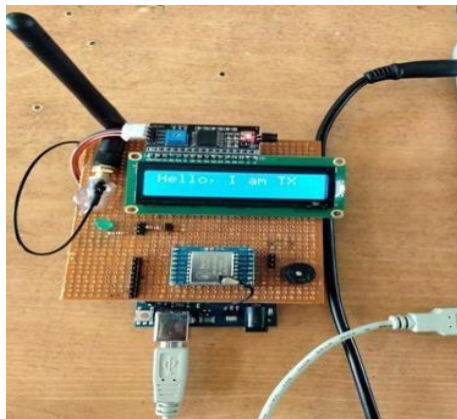

FIGURE 10: TRANSMITTER RESULT 1

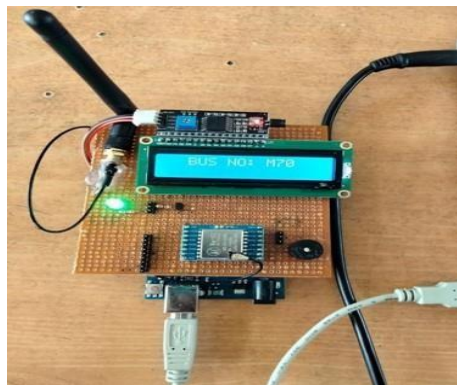

FIGURE 11: TRANSMITTER RESULT 2

B. RESULT OF RECEIVER



FIGURE 12: RECEIVER RESULT 1

9. CONCLUSION

The Bus stop confusion problem has been eliminated. Moreover, the project phase is completed successfully by using IOT. This project is made with pre-planning, which provides flexibility in operation. This innovation has made it more desirable and economical. This project “**ARDUINO AND LORA BASED BUS STOP REMINDER**” is designed with the hope that it is very much economical and helpful for passengers and as well as conductors during Journey.

10. REFERENCES

- [1] A study of a bus location system using LoRa: Bus location system for community bus “Notty” in 2017 IEEE 6th Global Conference on Consumer Electronics (GCCE).
- [2] Impact of Green Shading on Urban Bus Stop Structure in 2016 Second International Conference on Computational Intelligence & Communication Technology (CICT).
- [3] Smart bus for the smart city using IOT technology in 2018 international journal of advanced research in computer and communication engineering. (IJARCCE).
- [4] N. Abedi, A. Bhaskar, and E. Chung,(2010) Tracking Spatio-temporal movement of a human in terms of space utilization using media-access-control address data, *Appl. Geogr.*, vol. 51, pp. 72–81, Jul. 2014.
- [5] M. R. Amin-Naseri and V. Baradaran,(2010) Accurate estimation of average waiting time in public transportation systems, *Transp. Sci.*, vol. 49, no. 2, pp. 213– 222, Aug. 2014.
- [6] L. A. Bowman and M. A. Turnquist,(2015) Service frequency, schedule reliability and passenger wait times at transit stop, *Transp. Res. A Gen.*, vol. 15, no. 6, pp. 465– 471, Nov. 1981.
- [7] Danalet, B. Farooq, and M. Bierlaire,(2017) A Bayesian approach to detect pedestrian destination-sequences from WiFi signatures, *Transp. Res. C, Emerg. Technol.*, vol. 44, pp. 146–170, Jul. 2014.
- [8] R.Fernández,(2017) Modelling public transport stops by microscopic simulation, *Transp. Res. C, Emerg. Technol.*, vol. 18, no. 6, pp. 856–868, Dec. 2010.
- [9] V. Guihaire and J.-K. Hao,(2018) —Transit network design and scheduling: A global review, *Transp. Res. A Policy Pract.*, vol. 42, no. 10, pp. 1251–1273, 2008.
- [10] Brief encounters: Sensing, modeling, and visualizing urban mobility and copresence networks, *ACM Trans. Comput.-Hum. Interact.*, vol. 17, pp. 1–38, Mar. 2010.
- [11] T. V. Le, B. Song, and L. Wynter,(2018) Real-time prediction of length of stay using passive Wi-Fi sensing, in *Proc. IEEE ICC*, May 2017, pp. 1–6.
- [12] Y. Liu, J. Bunker, and L. Ferreira,(2019) Transit users’ route-choice modeling in transit assignment: A review,

Transp. Rev., vol. 30, no. 6, pp. 753–769, Oct. 2010.

- [13] B. M. Musa and J. Eriksson, (2016) Tracking unmodified smartphones using Wi-Fi monitors in Proc. 10th ACM Conf. Embedded Netw. Sens. Syst., Nov. 2012, pp. 281–294.
- [14] J. Manweiler, N. Santhapuri, R. R. Choudhury, and S. Nelakuditi, (2017) Predicting length of stay at WiFi hotspots, in Proc. IEEE INFOCOM, Apr. 2013, pp. 3102–3110.
- [15] M. Musa and J. Eriksson, (2016) —Tracking unmodified smartphones using Wi-Fi monitors in Proc. 10th ACM Conf. Embedded Netw. Sens. Syst., Nov. 2012, pp. 281–294.